

■ FIG. 20-30 REDUCED PORT 1/4" TO 1" 2000 PSI 1 1/4" TO 2" 1500 PSI

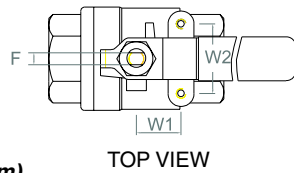

TOP VIEW

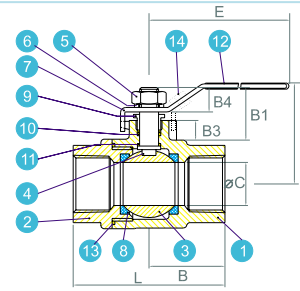

■ DIMENSIONS(mm)

| SIZE | B | B1 | B3 | B4 | ØC | E | F | H | L | W1 | W2 | W(kg) |
|--------|------|------|----|------|------|-----|-----|----|-----|------|------|-------|
| 1/4" | 27.5 | 18.2 | 6 | 11.6 | 9.5 | 100 | 5.0 | 50 | 51 | 12.7 | 28.5 | 0.22 |
| 3/8" | 27.5 | 18.2 | 6 | 11.6 | 11.6 | 100 | 5.0 | 50 | 51 | 12.7 | 28.5 | 0.22 |
| 1/2" | 32.0 | 23.5 | 8 | 11.6 | 12.6 | 100 | 5.0 | 50 | 51 | 12.7 | 28.5 | 0.28 |
| 3/4" | 37.5 | 25.0 | 11 | 11.6 | 15.0 | 130 | 6.5 | 53 | 68 | 22.4 | 35.0 | 0.45 |
| 1" | 43.5 | 25.3 | 9 | 11.6 | 20.0 | 130 | 6.5 | 64 | 83 | 22.4 | 35.0 | 0.66 |
| 1 1/4" | 51.0 | 33.5 | 13 | 15.2 | 25.0 | 165 | 8.0 | 66 | 90 | 22.4 | 35.0 | 1.08 |
| 1 1/2" | 55.0 | 31.0 | 9 | 15.2 | 32.0 | 165 | 8.0 | 79 | 104 | 25.4 | 38.1 | 1.49 |
| 2" | 63.0 | 31.6 | 9 | 16.6 | 38.0 | 190 | 9.7 | 83 | 117 | 25.4 | 38.1 | 2.32 |

■ FIG. 20-40 FULL PORT 1/4" TO 1" 2000 PSI 1 1/4" TO 2" 1500 PSI

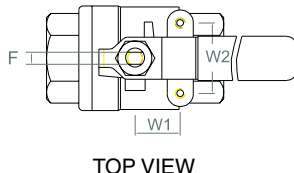

TOP VIEW

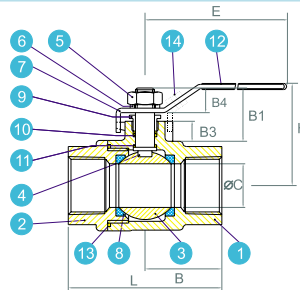

■ DIMENSIONS(mm)

| SIZE | B | B1 | B3 | B4 | ØC | E | F | H | L | W1 | W2 | W(kg) |
|--------|------|----|----|----|------|-----|-----|----|-----|------|------|-------|
| 1/4" | 27.5 | 23 | 8 | 10 | 11.6 | 100 | 5.0 | 50 | 55 | 12.7 | 28.5 | 0.23 |
| 3/8" | 27.5 | 23 | 8 | 10 | 12.7 | 100 | 5.0 | 50 | 55 | 12.7 | 28.5 | 0.23 |
| 1/2" | 32.5 | 26 | 10 | 12 | 15.0 | 130 | 6.5 | 60 | 65 | 12.7 | 28.5 | 0.38 |
| 3/4" | 37.0 | 26 | 11 | 12 | 20.0 | 130 | 6.5 | 64 | 74 | 22.4 | 35.0 | 0.52 |
| 1" | 44.0 | 30 | 12 | 15 | 25.0 | 165 | 8.0 | 71 | 88 | 22.4 | 35.0 | 0.92 |
| 1 1/4" | 51.0 | 37 | 12 | 15 | 32.0 | 165 | 8.0 | 78 | 102 | 25.4 | 38.1 | 1.32 |
| 1 1/2" | 55.0 | 35 | 12 | 16 | 38.0 | 190 | 9.7 | 86 | 110 | 25.4 | 38.1 | 1.90 |
| 2" | 62.5 | 31 | 10 | 16 | 50.0 | 190 | 9.7 | 95 | 125 | 25.4 | 38.1 | 3.12 |

■ FIG. 20-50 FULL PORT 1/2" TO 3" 1000 PSI

- Mounting Pad to DIN 3337/ISO 5211 with Center-Ring Top Fully machined.
- Live Loaded Stem Packing

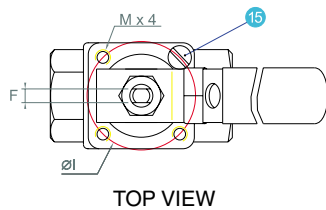

TOP VIEW

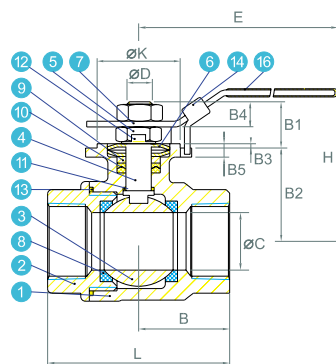

■ DIMENSIONS(mm)

| SIZE | B | B1 | B2 | B3 | B4 | B5 | ØC | ØD | E | F | H | ØI | ØK | L | M | ISO5211 |
|--------|------|------|------|----|------|----|------|------|-----|------|-----|-----|----|-------|-----|---------|
| 1/2" | 32.5 | 18.5 | 27.5 | 2 | 11.0 | 5 | 15.0 | 9.5 | 130 | 6.5 | 69 | 36 | 25 | 65.0 | M5 | F03 |
| 3/4" | 37.2 | 20.5 | 32.6 | 2 | 12.0 | 5 | 20.0 | 9.5 | 130 | 6.5 | 74 | 36 | 25 | 74.5 | M5 | F03 |
| 1" | 44.0 | 18.0 | 44.0 | 2 | 10.0 | 6 | 25.0 | 11.0 | 165 | 8.0 | 83 | 42 | 30 | 88.0 | M6 | F04 |
| 1 1/4" | 51.3 | 18.0 | 49.6 | 2 | 11.0 | 6 | 32.0 | 11.0 | 165 | 8.0 | 92 | 42 | 30 | 102.0 | M6 | F04 |
| 1 1/2" | 55.0 | 24.0 | 54.1 | 2 | 12.5 | 6 | 38.0 | 14.0 | 222 | 9.7 | 104 | 50 | 35 | 110.0 | M8 | F05 |
| 2" | 64.9 | 24.0 | 62.5 | 2 | 12.5 | 6 | 50.0 | 14.0 | 222 | 9.7 | 104 | 50 | 35 | 127.5 | M8 | F05 |
| 2 1/2" | 80.6 | 32.8 | 83.6 | 2 | 20.0 | 8 | 65.0 | 19.0 | 250 | 12.0 | 140 | 70 | 55 | 160.6 | M8 | F07 |
| 3" | 91.0 | 32.8 | 92.3 | 2 | 20.0 | 8 | 80.0 | 19.0 | 250 | 12.0 | 149 | 102 | 70 | 178.0 | M10 | F10 |

■ MATERIALS LIST

| NO. | PART NAME | MATERIAL | QTY |
|-----|-------------------|--------------------|-----|
| 1 | Body | ASTM A351 Gr. CF8M | 1 |
| 2 | End cap | ASTM A351 Gr. CF8M | 1 |
| 3 | Ball | SUS 316 | 1 |
| 4 | Stem | SUS 316 | 1 |
| 5 | Stem Nut | SUS 304 | 2 |
| 6 | Belleville Washer | SUS 301 | 2 |
| 7 | Handle | SUS 304 | 1 |
| 8 | Seat | PTFE | 2 |
| 9 | Gland | SUS 304 | 1 |
| 10 | V-Ring Packing | PTFE | 1 |
| 11 | Thrust Washer | PTFE | 1 |
| 12 | Lock Saddle | SUS 304 | 1 |
| 13 | Joint Gasket | PTFE | 1 |
| 14 | Locking Device | SUS 304 | 1 |
| 15 | Stop Pin | SUS 304 | 1 |
| 16 | Handle Sleeve | Vinyl | 1 |

1 Set of v-ring packing consists of 2pcs of v-ring

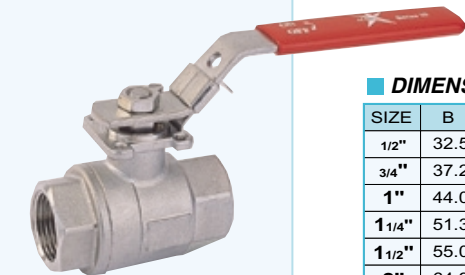

MARS VALVE CO.,LTD.
 7F-6, NO.200, SEC. 4, WEN-SHIN ROAD
 TAICHUNG, TAIWAN, R.O.C.
 TEL:++886-4-297 3808
 FAX:++886-4-297 3608
 E-MAIL:mars@marsvalve.com.tw
<http://www.marsvalve.com.tw/>

Distributor: